

General Description

The IDT8N4S270 is a Factory Frequency-Programmable Crystal Oscillator with very flexible frequency programming capabilities. The device uses IDT's fourth generation FemtoClock® NG technology for an optimum of high clock frequency and low phase noise performance. The device accepts 2.5V or 3.3V supply and is packaged in a small, lead-free (RoHS 6) 6-lead ceramic 5mm x 7mm x 1.55mm package.

The device can be factory programmed to any in the range from 15.476MHz to 866.67MHz and from 975MHz to 1,300MHz and supports a very high degree of frequency precision of 218Hz or better. The extended temperature range supports wireless infrastructure, telecommunication and networking end equipment requirements.

Features

- Fourth generation FemtoClock® NG technology
- Factory-programmable clock output frequency from 15.476MHz to 866.67MHz and from 975MHz to 1,300MHz
- Frequency programming resolution is 218Hz and better
- One 2.5V, 3.3V LVDS clock output
- Output enable control (positive polarity), LVCMOS/LVTTL compatible
- RMS phase jitter @ 231.25MHz (12kHz - 20MHz): 0.48ps (typical), integer PLL feedback configuration
- RMS phase jitter @ 231.25MHz (1kHz - 40MHz): 0.50ps (typical), integer PLL feedback configuration
- 2.5V or 3.3V supply
- -40°C to 85°C ambient operating temperature
- Available in a lead-free (RoHS 6) 6-pin ceramic package

Block Diagram

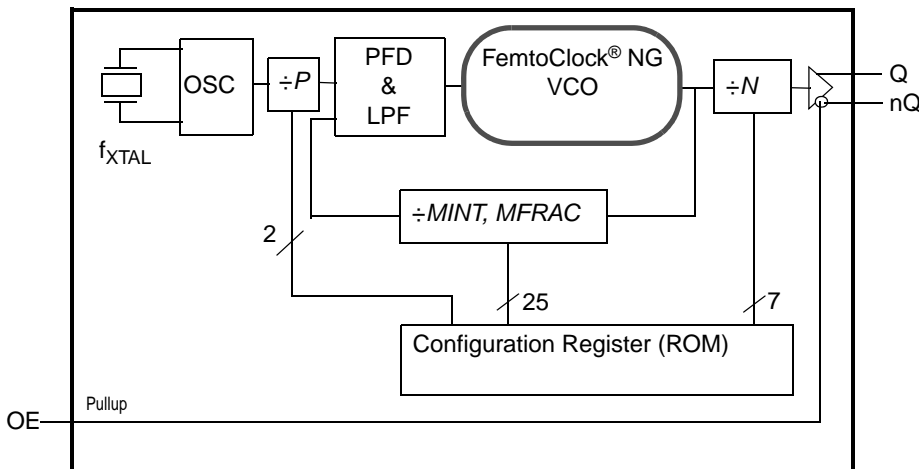

Pin Assignment

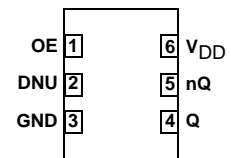

IDT8N4S270
6-lead ceramic 5mm x 7mm x 1.55mm
package body
CD Package
Top View

Package Outline and Package Dimensions

